

APPLICATIONS OF FLAT GEOMETRY REMOTE FIELD EDDY CURRENT TECHNIQUES IN AIRCRAFT NONDESTRUCTIVE INSPECTION

Y. Sun and T. Ouyang

Innovative Materials Testing Technologies, Inc., Ames, Iowa, USA

Abstract: The Flat Geometry Remote Eddy Current (FG RFEC) Technique has its unique advantages in aircraft non-destructive inspection (NDI) including deep penetration, high sensitivity, portability, low price, etc. The technique has recently been recognized by aircraft NDI societies.

Currently FG RFEC technique is capable of detecting deeply hidden cracks and corrosion flaws. This paper will introduce the recent progresses made in R&D of the FG RFEC technique including:

1. Accurate detection of inner layer fastener hole cracks in multiple layer aircraft structures using rotational FG RFEC probes and an auto-centering device;
2. Accurate detection of landing gear cross-bolt hole cracks through bushing;
3. Detection and calibration of deeply hidden corrosion in multiple layer aircraft structures.

The Super-Sensitive Eddy Current (SSEC) system, used as the instrumentation tool for FG RFEC technique, will also be introduced. The project is currently supported by Federal Aviation Administration of United States of America.

Introduction: Greater and greater impact comes from the aging of currently in-service airplanes. Two of the most important issues affecting possible extending the life of aging airplanes are cracking and corrosion. Therefore, a good non-destructive inspection (NDI) technique for aircraft corrosion and cracking inspection is essential to the safety of aging airplanes.

Aircraft components often suffer from fatigue cracking and corrosion because their particular working environment. Conventional NDI techniques are incapable of detecting for inner layer fatigue cracks and corrosion from aircraft exterior; therefore, to inspect inaccessible areas of an aircraft component usually requires the removal of obstructions or disassembly prior to inspecting the desired component.

An airplane is inspected every given flight-hours or given landing cycles. It is often that such an inspection is unnecessary since cracking or corrosion may not be present. Such an inspection is costly, because the direct cost spent on the inspection consists of only a couple of percent of the total cost. The costs of other related work, including the teardown, replacement, and parking costs, are dominating.

Therefore, there is a demand for advanced NDI techniques for aircraft fatigue damage and corrosion detection. The major requirements to such a new NDI technique include:

1. Detect inner layer cracks/corrosion from outside aircraft skin through multi-layered structures. The number of layers can be up to 5.
2. Deep penetration to cover possible aircraft thickness which can be up to 5-10 centimetres of aluminium alloy, titanium alloy and/or composite structure.
3. Sensitivity to small-sized inner layer crack/corrosion with and without presence of fasteners of different materials.
4. Reliability of detection without human factors involved.
5. High-speed and large-area inspection considering all the above 1-4 requirements.
6. Discriminate noises from different factors, such as edge effect, thickness variations and possible sealant/gaps between layers, etc.
7. Low cost.

8. Portability and convenience in use.

There are quite a number of aircraft NDI techniques including conventional and emerging techniques. However, until now there is no single one that meets all the above requirements. Examples include:

1. Ultrasonic techniques (UT), including guided wave UT, is incapable of penetrating through multiple layer structures and restricted to first layer and upper surface of second layer inspection;
2. X-ray techniques involve heavy equipment, protecting operators from radiation, is relatively expensive and of low sensitivity to small cracks.
3. Most eddy current (EC) techniques and its alternatives have limited potential for further increase of their penetration depth in metallic structures because of skin-depth effect;
4. One exception can be listed is Super-conducting Quantum Interface Device (SQUID). It is capable of penetrating relatively deep. However, the system is quite heavy, large, expensive and having high noise problems. These issues restrict its practical applications.

Among current emerging aircraft NDI techniques FG RFEC & SSEC system has shown great promise in becoming a good candidate for expected aircraft NDI needs in the near future.

FG RFEC and SSEC System [1-3]

The original Remote Field Eddy Current (RFEC) has used in NDI of conducting tubing for years. The RFEC technique is characterized by its features of deep penetration and the linear relation of its signal phase to the total wall thickness under inspection. The signal phase to wall thickness relation is independent of probe lift-off and the location of a flaw in respect to the wall thickness.

IMTT has expanded the applications of RFEC techniques to the inspections of conducting objects of flat or nearly flat geometries with the help of specially designed probes called FG RFEC probes, Figure 1. The probe blocks the direct coupling path. The electromagnetic energy released from the drive unit is forced by an FG RFEC probe to go along the indirect coupling path. Therefore, all signal received by the pickup unit has passed the wall twice and carries the entire information about the wall condition. The signal can be extremely weak, but is very clean without noise coming from the driving unit.

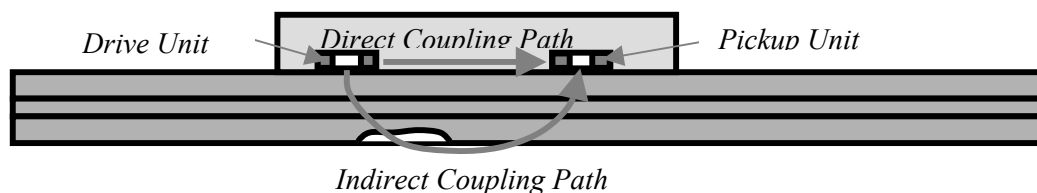

Figure 1. Simplified drawing of an FG RFEC probe and the energy coupling paths.

An SSEC system is a modified version of a conventional eddy-scope. An SSEC system has comparatively high gain and low noise level. It brings the weak pickup signal to a level that is readable on a computer screen.

Current version of an SSEC system consists of a piece of software and a Printed Circuit Board (PCB) that are installed/inserted into a regular personal or industrial computer, see the left picture in Figure 2. It utilizes the fundamental features of a computer as the base of an SSEC system. Figure 2 right is the second version of the system where it becomes a small box and can be connected to a customer preferred computer through a universal serial port (USB). This version will be available soon.

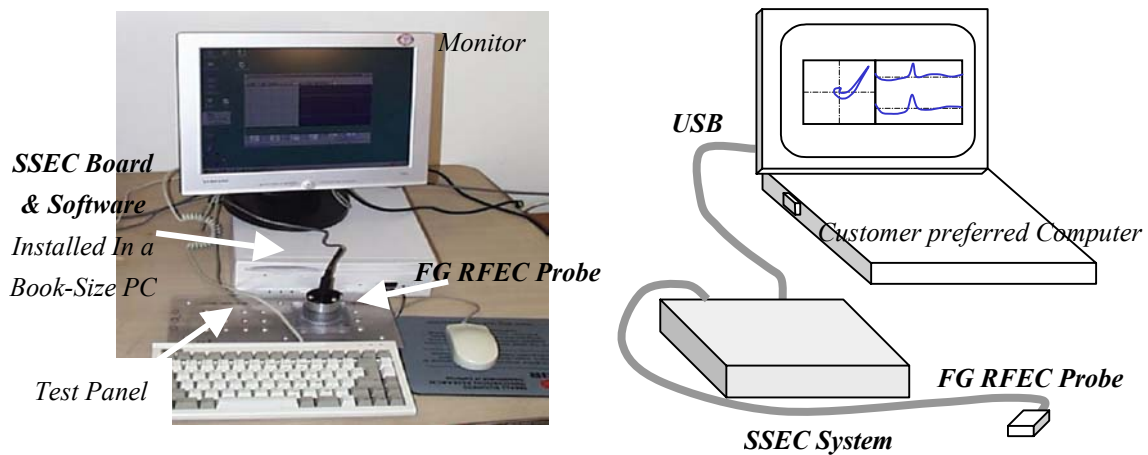

Figure 2. Current (left) and future (right) versions of an SSEC system.

Rotational FG RFEC and SSEC System for Crack Detection

For the purpose of accurate and fast detection of fastener hole cracks a series of rotational RFEC probes with accompanying software have been developed.

Traditionally a raster scan mode is used for crack detection. In such a mode a probe moves in X and Y direction over entire area of interest. The raster scan mode has a disadvantage as inner-layer crack signals are submerged by the fastener signals/noises, which may be tens or hundreds times greater than the crack signals. A rotational probe with a centered excitation coil and a off-set differential sensor may minimize the noises if the probe is rotating right at the fastener center because of the geometric symmetry, Figure 3. When probe rotation center coincides with fastener center, we should have a zero signal from the differential sensor when there is non crack. A signal appears in the differential sensor only when it passes a crack.

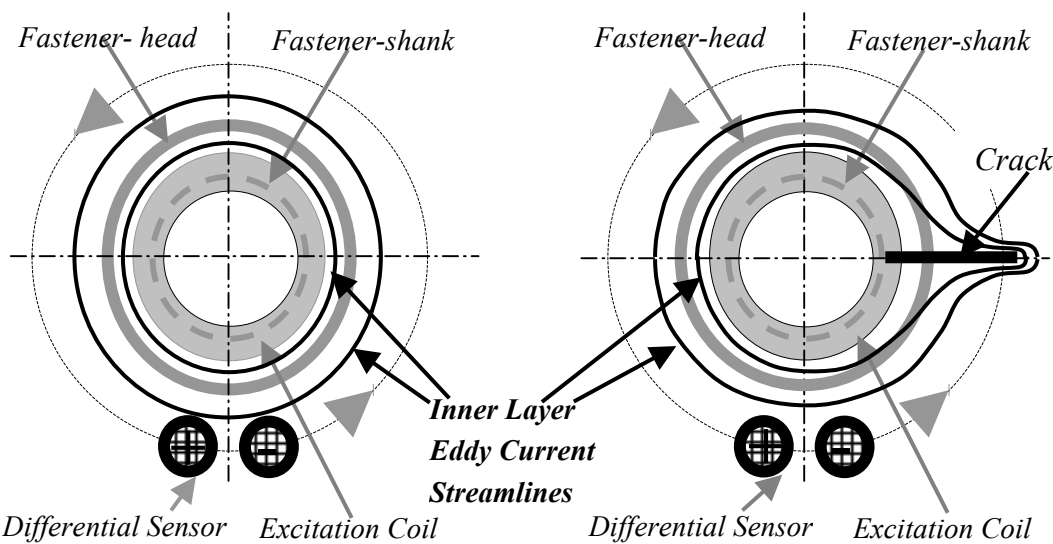

Figure 3. Rotating probe minimizes noises from fastener because of symmetry in geometry. No-crack case (left) and with an inner layer crack (right)

However, to have a rotational FG RFEC probe work with high sensitivity the probe must be centered well with the fastener under inspection.

Inspection of Raised-Head Fasteners [4]

One example of application of rotational FG RFEC probe in aircraft crack detection is inspection of raised-head fasteners, Figure 4.

Raised-head fasteners are often used in helicopter structures. They are also seen on non-aerodynamic surfaces of conventional airplanes. The round fastener head can work as a guide for the probe rotation if a pocket, that closely matches the outer diameter of the fastener head, is made on an FG RFEC probe head.

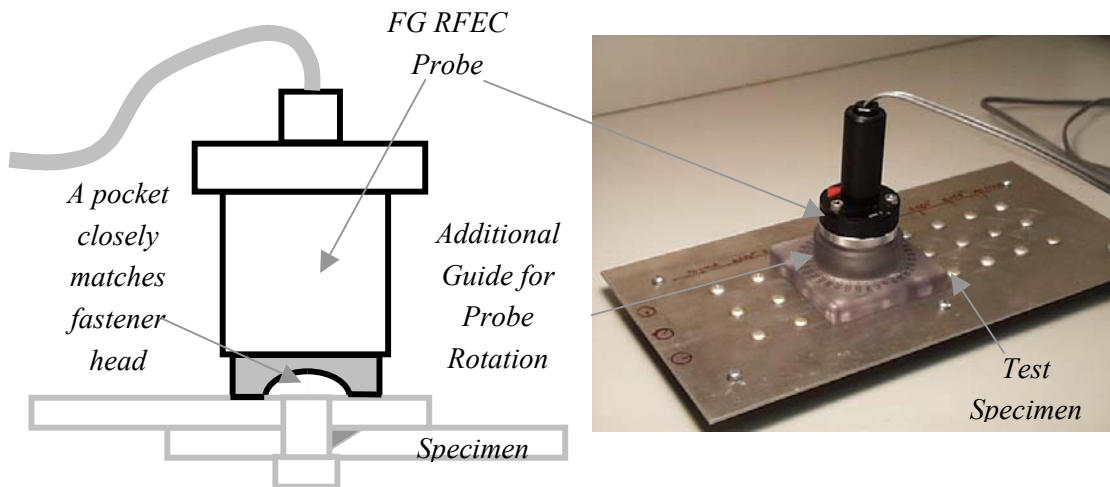

Figure 4. Rotational FG RFEC probe applied to raised-head fastener

The FG RFEC probe for inspection of raised-head fasteners have been extensively tested on different panels provided by Airworthiness Assurance NDI Validation Center (AANC), Federal Aviation Administration (FAA) of The United States at Sandia National Laboratories, Albuquerque, NM, USA. The probe keeps the best Probability Of Detection (POD) record in detection inner-layer cracks for two layer, 1.0mm + 1.0mm, aircraft aluminum structures. The rotational FG RFEC probe has also been used for detection of real fatigue crack and EDM notches in flush-head fastener holes for complex aircraft structures made of different materials including aluminum and titanium.

Currently the probes with different pocket diameters are in the process of its first production. They will be available, together with an SSEC unit, shortly on the market. We are also working on detection of fastener-hole cracks at much thicker structures.

See next paragraph for test result examples.

Auto-centering System

A centering process is critical to accurate inspection of flush-head fasteners. Visual observation is not accurate for detecting cracks in flush-head fastener holes detection, especially for inner layer crack detection. Furthermore, it has been noticed that the signal/electric center, where we see the minimum of signal magnitude at no-crack case, may not necessarily be the geometrical center of the fastener.

An auto-centering system, Figure 5, is used to help find the electric center of the fastener under inspection and place a rotational FG RFEC probe precisely there. Three motors are used in an auto-centering device, one is for probe rotation, the other two are for moving the probe in X and Y directions. At each (x, y) position the probe, working with SSEC, collects detected signal and send the data to the PC.

A build-in software processes the data and, then, provides a command to the controller telling it the necessary information regarding the next step of probe movement. When the probe has already reached the electric center, the intelligent software asks to pop up on PC screen the inspection report: “No-Crack”, “Crack Found”, “Significant S/N Ratio”, and other information related to the detection.

With the help of an auto-centering system the accuracy, reliability, repeatability and inspection speed have all improved greatly in inspection of flush-head fasteners. See typical test results in next paragraph.

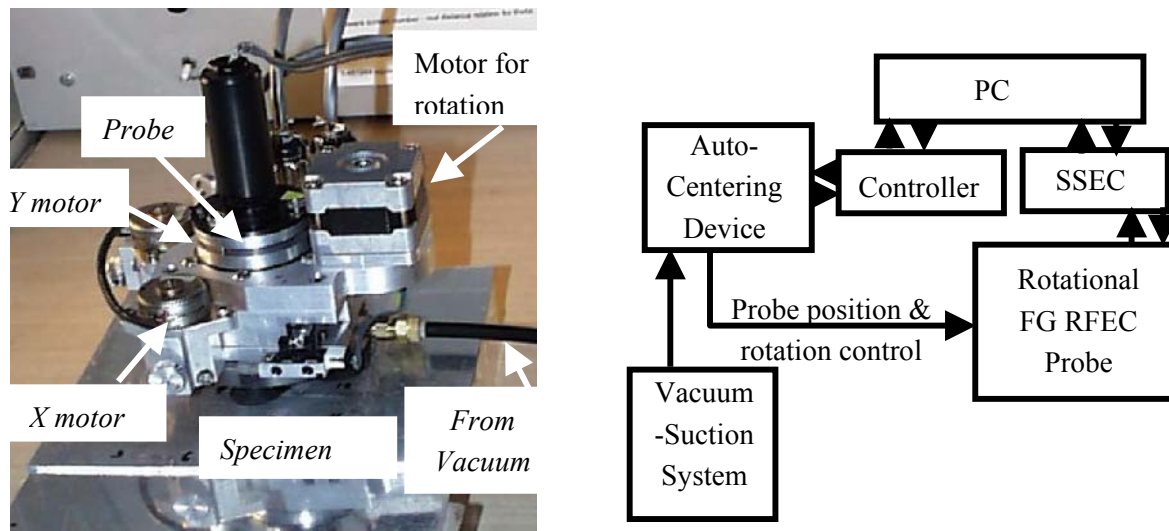

Figure 5. Auto-Centering Device (left) and Auto-centering system – A Block Diagram (right)

Detecting Cross-Bolt Hole cracks Underneath Bushing [5]

Cross-bolt holes are often seen in aircraft structures, such as landing gears. These holes often experience high stress and even cracking during particular operations, such as hard landing. It is very often that a bushing is tightly installed in the inner diameter (ID) of a cross-bolt hole. Therefore, a crack in a cross-bolt hole is very difficult to be detected using traditional NDI methods unless the bushing is removed from the hole. Removal of a tightly installed bushing from a cross-bolt hole is not only costly, but may also bring new damage to the structure.

Three different techniques are currently used for inspection of the cracks under bushing that requires a long inspection time and provides very low sensitivity and S/N ration. It is an urgent demand to develop a simple and low-cost NDI system that can detect all cross-hole cracks through bushing with low noise and high sensitivity.

Development of the first prototype of an FG RFEC probe was targeted on Boeing NDT Standard 636 that is simulating a cross-bolt hole on Boeing 767 landing gear structure, Figures 6 and 7. The cross-bolt lug is made of steel. A brass bushing of 2 mm thick is installed in the inner diameter.

The probe developed for inspection of the target has an excitation coil and a pickup coil. They are separated by a center-center distance of 5.84 mm. The probe design has successfully forced the signal going through the bushing wall, reach the EDM notches made on the lug, and realize the remote field eddy current effect around the area of inspection.

Currently an evaluation prototype of the probe, ordered by Boeing Commercial Airplanes, is under design and fabrication.

Using the FG RFEC probe prototype all EDM notches made on the standard have been successfully detected. The sensitivity of detection has been improved significantly: Modifications have made on the NDI Standard 636. Addition to the existing three EDM notches three much smaller EDM notches machined on the Standard. The FG RFEC probe has detected all the EDM notches with significant high S/N ration. Typical test results are shown in next paragraph.

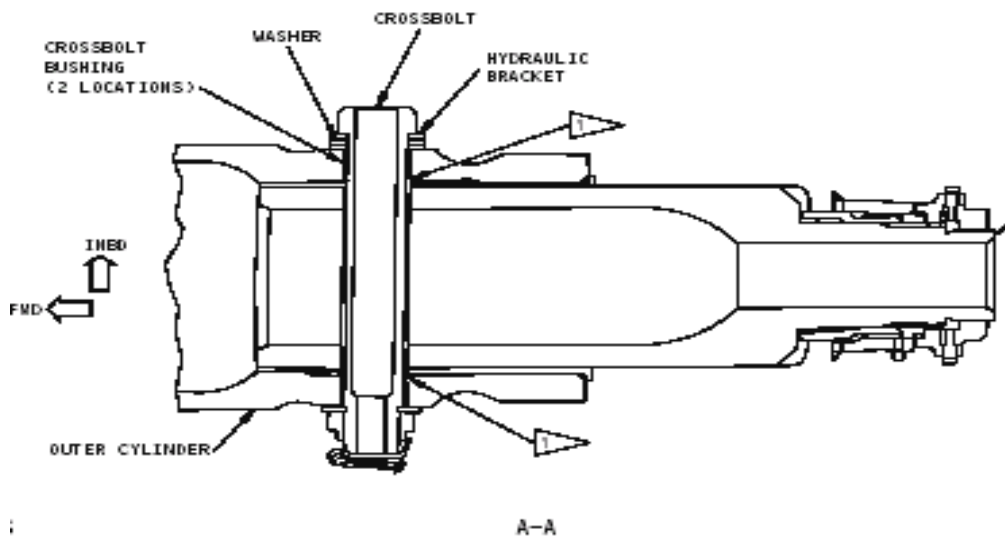

Figure 6. Cross-bolt holes and bushings in a Boeing 767 Landing gear structure

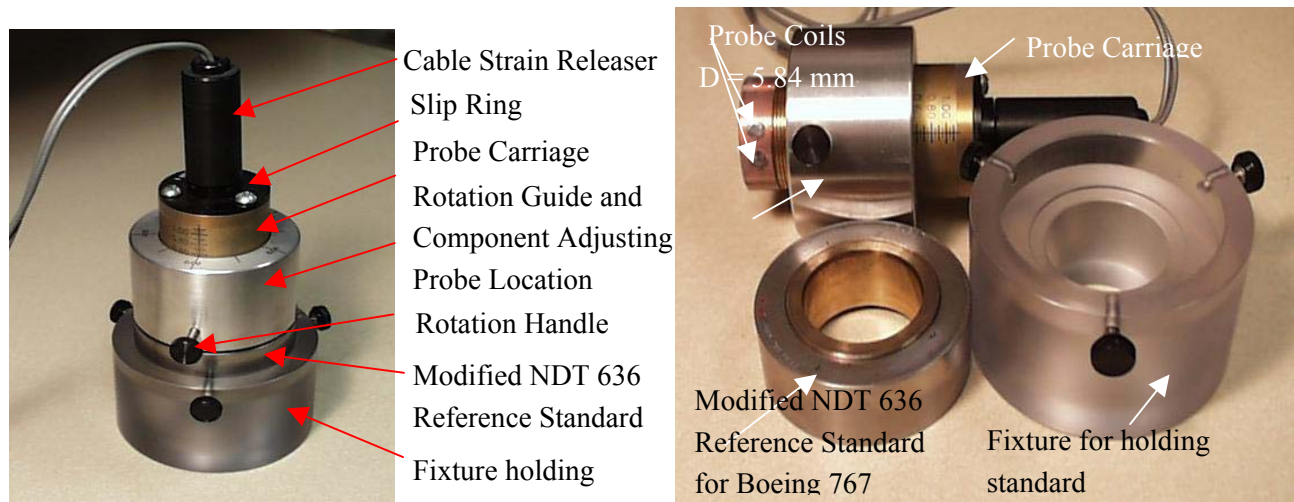

Figure 7. An FG RFEC probe for detecting cross-bolt hole cracks under bushing

Detection and calibration of deeply hidden corrosion in multiple layer aircraft structures [6]

Detection of deeply hidden corrosion in a multilayer aircraft structure has been a challenge to NDT society for a long time. Eddy current techniques (ECT) are considered the best choices in penetrating through multilayer structures. However, so far conventional ECTs and most emerging ECTs are incapable of effectively detecting corrosion that is hidden > 10 mm below in an aluminum structure. SQUID is an exception. However, the tremendously high cost and geometrical dimensions prevent it from practical aircraft applications.

FG RFEC technique has inherent advantage in deep penetration through multilayer conductive structures. With currently available FG RFEC probes and SSEC system this technique, using excitation power no more than 0.4 volt-ampere, can:

1. Detecting 1.0 mm deep corrosion that is 20 mm below surface on a multilayer aluminum structure ;
2. Detecting 0.1 mm deep corrosion that is 3.1 mm below surface on an aluminum plate;

3. Detecting a 0.8 mm diameter 0.4 mm deep drill hole that is 3.1 mm below surface on an aluminum plate.

Please see the test data in next paragraph.

Results: Below are typical test results showing the capabilities of the FG RFEC and SSEC technique in NDI of aircraft cracking and corrosion:

Example 1: Detecting edm notches in a “very conductive” alodined fastener panel

Alodined fasteners have been used on airplanes since 1985. An alodined fastener has a good conducting surface and is different from the original anodized fastener its surface is not conductive. Recently The Boeing Company has noticed that the crack signals detected from alodined fasteners using a number of conventional and emerging EC technologies can be much smaller than those detected from anodized fasteners. A crack signal may be lower than signals detected from no-crack anodized fasteners. This brings a challenge to aircraft NDI society.

The investigation to date shows that the FG RFEC and SSEC technique is one of the solutions for this issue. Figure 8 shows test results obtained from a “very conductive” alodined fastener using an Auto-Centering FG RFEC AND SSEC technique compared with signals obtained from no-EDM fastener holes. The panel is provided by Mr. Jeff Kollgaard, Boeing Commercial airplanes.

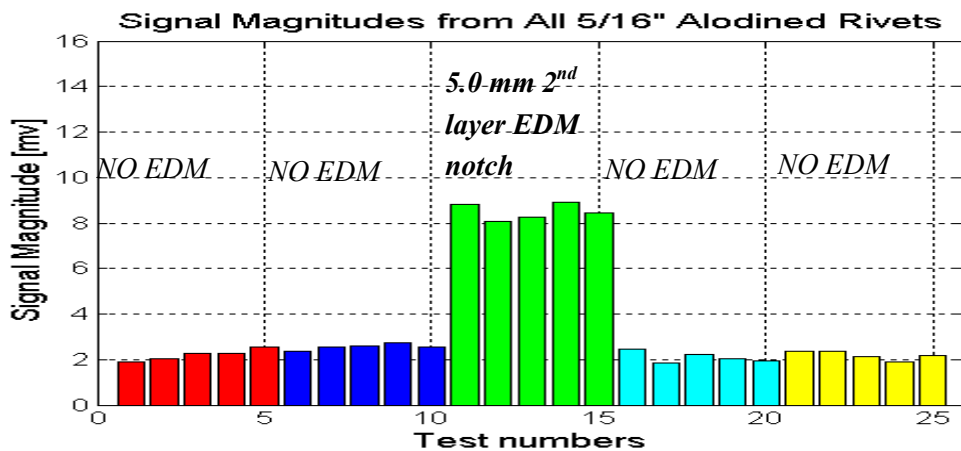
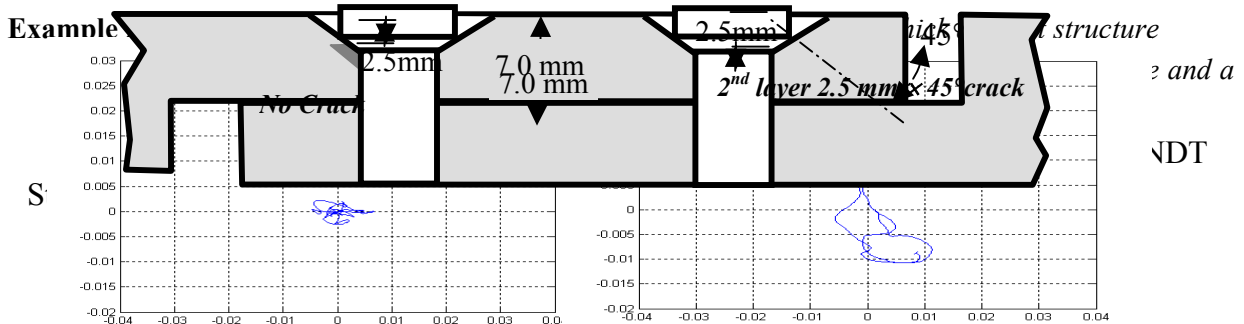
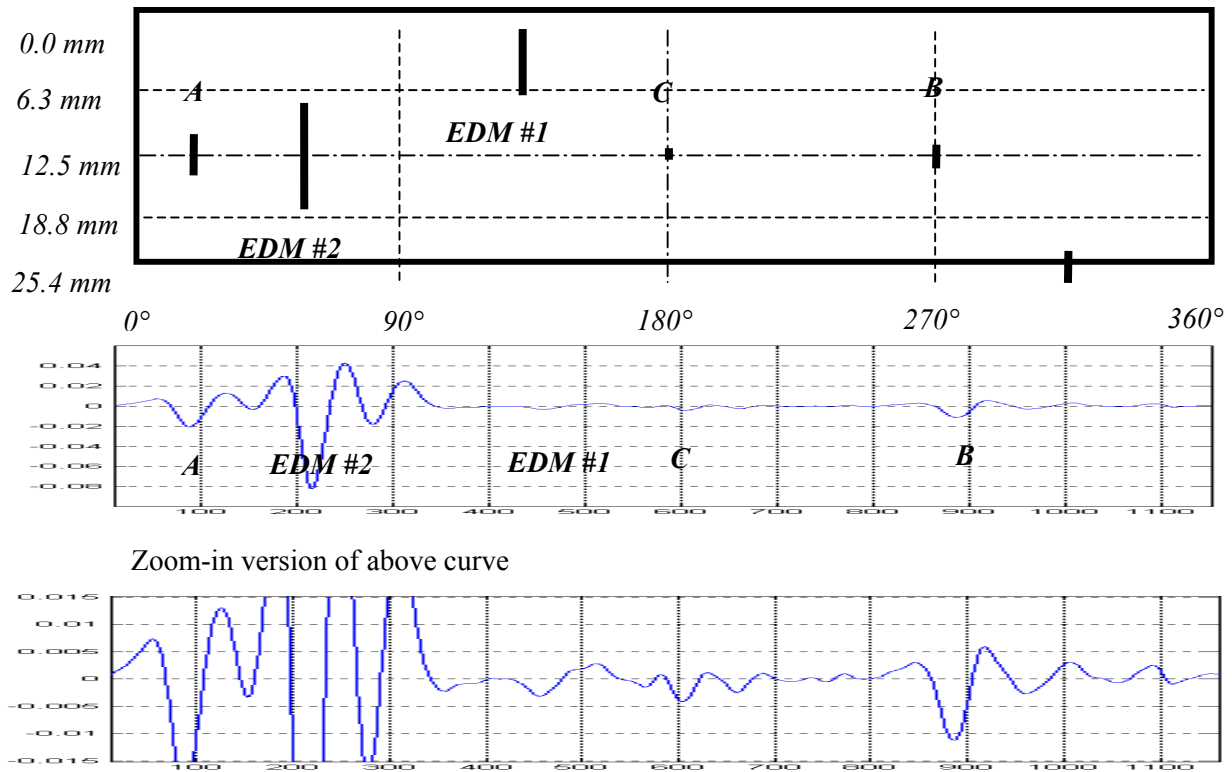

Figure 8. Detected EDM signals compared with signals obtained from NO-EDM fastener hole





360° rotation of the probe.

Example 4: Detecting 1 mm deep corrosion that is 15 mm below surface in a multilayer aluminium structure

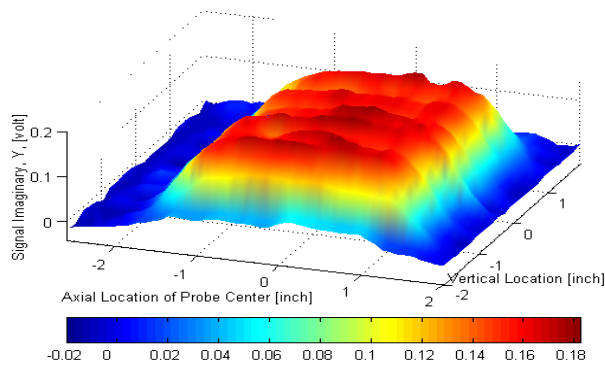
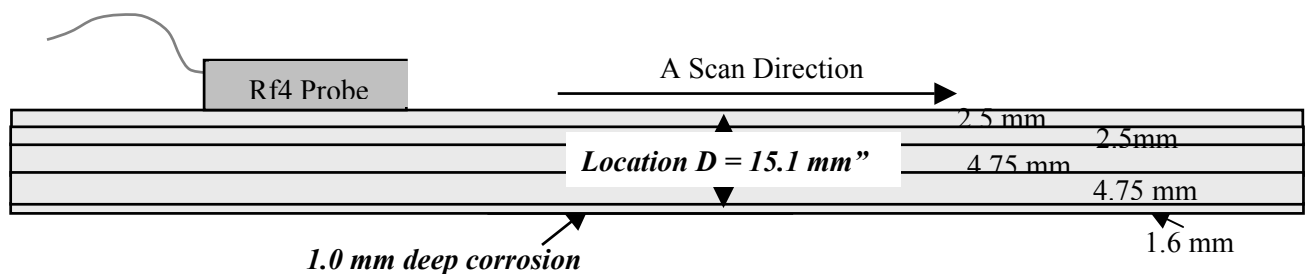

76 mm × 76 mm × 1 mm Flat-bottom corrosion
15.1 mm Below Surface

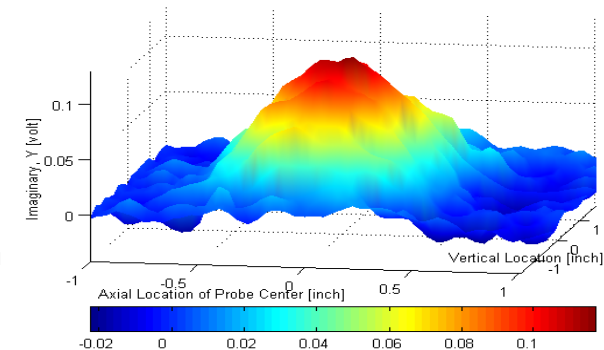

12.7 mm × 12.7 mm × 1 mm Flat-bottom corrosion
15.1 mm Below Surface

Figure 10. Deep corrosion detection. Specimen (upper) and images (lower)

Deeply hidden corrosion can be detected and calibrated with the FG RFEC technique using signal-magnitude and phase angle. Actually the phase angle detected from a hidden corrosion does not change much with the corrosion depth, see the left plot of Figure 11. Therefore, the location of a corrosion,

L , on top of bottom of which layer of a structure under inspection, can be easily determined by the signal phase angle. Once L is found out, the corrosion size/diameter, D , can be determined by the signal magnitude, as shown in the right plot of Figure 11.

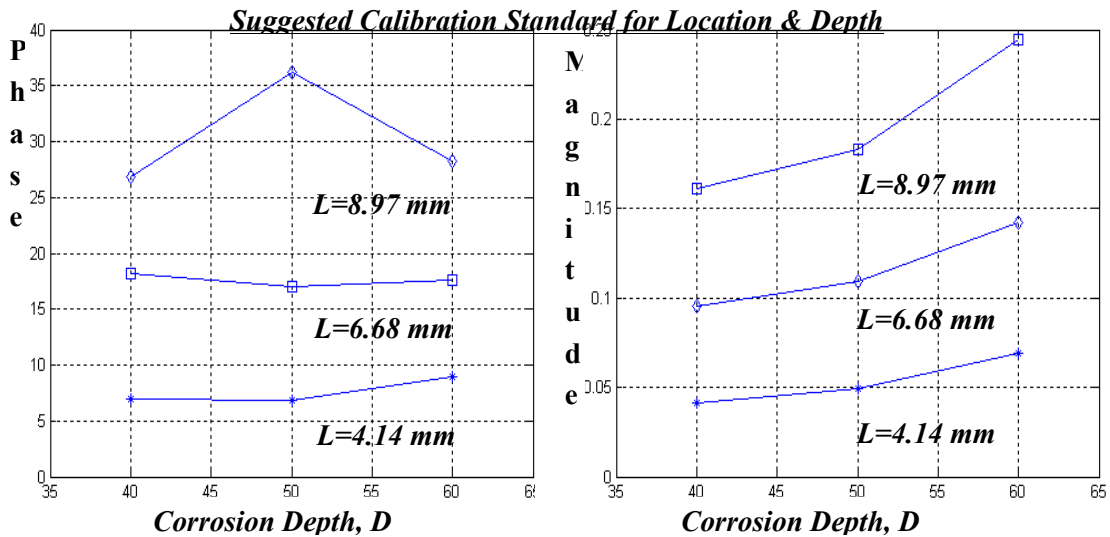

Figure 11. Plots for calibrating a deeply hidden corrosion flaw

Discussion and Conclusions: Three applications of the FG RFEC and SSEC technique in aircraft NDI have been introduced. Typical test examples have also provided to show the effectiveness of the technique. The test results have shown good promise of this technique in aircraft NDI applications.

References:

[1]. J. Y.S. Sun, T. Ouyang and S Udpa, “Remote Field Eddy Current Testing: One of the Potential Solution for Detecting Deeply Embedded Discontinuities in Thick and Multilayer Metallic Structures”, *Materials Evaluation*, Volume 59/Number 5, May 2001.

[2]. Yu-shi Sun, US Patent 6,002,251, “Electromagnetic-Field-Focusing Remote-Field Eddy-Current Probe System and Method for Inspecting Anomalies in Conducting Plates”, Issue date: 12/14/1999.

[3]. Tian-He Ou-Yang, US Patent 6,636,037 “Super sensitive eddy-current electromagnetic probe and system for inspecting anomalies in conducting plates”, issued date: 10/21/2003.

[4]. Yushi Sun, Tianhe Ouyang, Jie Long, Denis Roach “Rotational Remote-Field Eddy Current Method For Detecting Cracks Under Raised Head Fasteners”, Presented at *The 7th FAA/DoD/NASA Joint Conference on Aging Aircraft*, New Orleans, LA, September 7-11, 2003.

[5]. Yushi Sun, Tianhe Ouyang, Jie Long, Jeff Thompson, Jeff Kollgaard, “Detecting Cracks Under Bushings With Rotational Remote-Field Eddy Current Probes”, Proceedings of *The 7th FAA/DoD/NASA Joint Conference on Aging Aircraft*, New Orleans, LA, September 7-11, 2003.

[6]. Yushi Sun, et al., “Building Calibration Standard Remote Filed Eddy Current Technique Detecting Deeply Hidden Corrosion in Aircraft Structures”, *5th International Aircraft Corrosion Workshop Proceedings*, Solomons, MA, August 20-23, 2002.